

PERFORMANCE
MADE
SMARTER

Product manual **3114**

Isolated universal converter

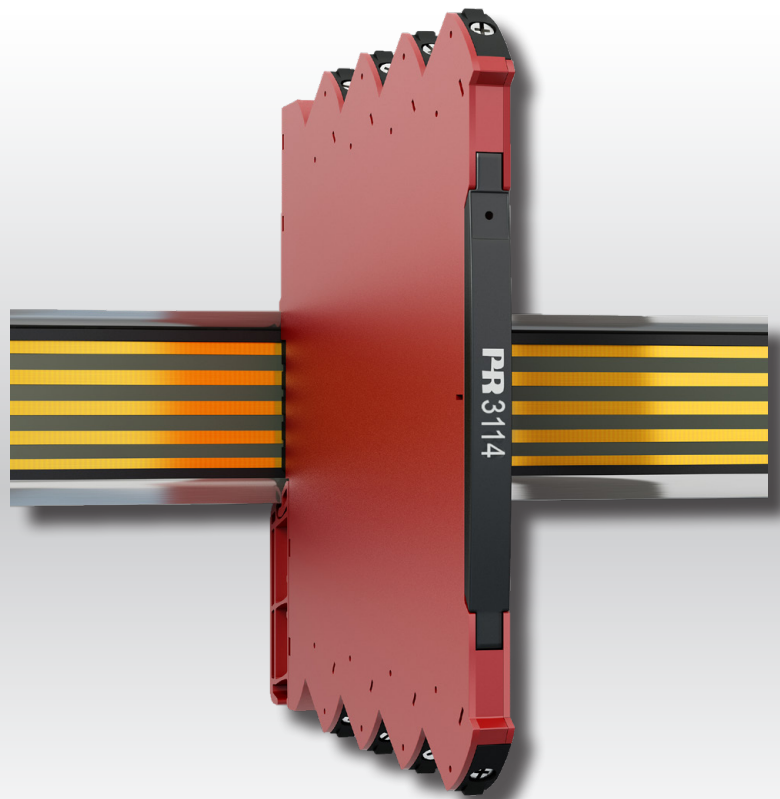

TEMPERATURE | I.S. INTERFACES | COMMUNICATION INTERFACES | MULTIFUNCTIONAL | ISOLATION | DISPLAY

No. 3114V105-UK
From serial no.: 211696077

PR
electronics

6 Product Pillars

to meet your every need

Individually outstanding, unrivalled in combination

With our innovative, patented technologies, we make signal conditioning smarter and simpler. Our portfolio is composed of six product areas, where we offer a wide range of analog and digital devices covering over a thousand applications in industrial and factory automation. All our products comply with or surpass the highest industry standards, ensuring reliability in even the harshest of environments and have a 5-year warranty for greater peace of mind.



Temperature

Our range of temperature transmitters and sensors provides the highest level of signal integrity from the measurement point to your control system. You can convert industrial process temperature signals to analog, bus or digital communications using a highly reliable point-to-point solution with a fast response time, automatic self-calibration, sensor error detection, low drift, and top EMC performance in any environment.



I.S. Interface

We deliver the safest signals by validating our products against the toughest safety standards. Through our commitment to innovation, we have made pioneering achievements in developing I.S. interfaces with SIL 2 Full Assessment that are both efficient and cost-effective. Our comprehensive range of analog and digital intrinsically safe isolation barriers offers multifunctional inputs and outputs, making PR an easy-to-implement site standard. Our backplanes further simplify large installations and provide seamless integration to standard DCS systems.



Communication

We provide inexpensive, easy-to-use, future-ready communication interfaces that can access your PR installed base of products. All the interfaces are detachable, have a built-in display for readout of process values and diagnostics, and can be configured via push-buttons. Product specific functionality includes communication via Modbus and Bluetooth and remote access using our PR Process Supervisor (PPS) application, available for iOS and Android.



Multifunction

Our unique range of single devices covering multiple applications is easily deployable as your site standard. Having one variant that applies to a broad range of applications can reduce your installation time and training, and greatly simplify spare parts management at your facilities. Our devices are designed for long-term signal accuracy, low power consumption, immunity to electrical noise and simple programming.



Isolation

Our compact, fast, high-quality 6 mm isolators are based on microprocessor technology to provide exceptional performance and EMC-immunity for dedicated applications at a very low total cost of ownership. They can be stacked both vertically and horizontally with no air gap separation between units required.



Display

Our display range is characterized by its flexibility and stability. The devices meet nearly every demand for display readout of process signals and have universal input and power supply capabilities. They provide a real-time measurement of your process value no matter the industry and are engineered to provide a user-friendly and reliable relay of information, even in demanding environments.

Isolated universal converter 3114

Table of contents

Warnings	4
Symbol identification	4
Safety instructions	5
Mounting / demounting of system 3000	6
Installation on DIN rail / power rail	7
Marking	7
Flexible supply	8
Applications	9
Technical characteristics	9
Product overview	9
Connections	10
Specifications	11
Order	11
Accessories	11
Technical data	11
Programming	15
Default configuration	15
PR 4590 ConfigMate programming	16
Display readout on the PR 4500 of sensor error detection and input signal outside range	17
Sensor error detection limits	17
Error indications	18
Advanced settings menu	19
Routing diagram	21
Routing diagram, advanced settings (ADV.SET)	22
Help text overview	23
Operation & troubleshooting	24
Installation instructions	25
UL installation	25
IECEX, ATEX and UKEX installation in Zone 2	25
cMus installation in Division 2 or Zone 2	25
Document history	26

Warnings



GENERAL

To avoid the risk of electric shock and fire, the safety instructions of this guide must be observed and the guidelines followed. The specifications must not be exceeded, and the device must only be applied as described in the following. Prior to the commissioning of the device, this installation guide must be examined carefully. Only qualified personnel (technicians) should install this device. If the equipment is used in a manner not specified by the manufacturer, the protection provided by the equipment may be impaired.

To avoid explosion and serious injury: Modules having mechanical failures must be returned to PR electronics for repair or replacement.

Repair of the device must be done by PR electronics A/S only.



**HAZARDOUS
VOLTAGE**

Until the device is fixed, do not connect hazardous voltages to the device.

In applications where hazardous voltage is connected to in-/outputs of the device, sufficient spacing or isolation from wires, terminals and enclosure - to surroundings (incl. neighboring devices), must be ensured to maintain protection against electric shock.

The connector behind the front cover of 3114 is connected to the input terminals on which dangerous voltages can occur.



CAUTION

Potential electrostatic charging hazard. To avoid the risk of explosion due to electrostatic charging of the enclosure, do not handle the units unless the area is known to be safe, or appropriate safety measures are taken to avoid electrostatic discharge.

Symbol identification



Triangle with an exclamation mark: Warning /demand. Potentially lethal situations. Read the manual before installation and commissioning of the device in order to avoid incidents that could lead to personal injury or mechanical damage.



The CE mark proves the compliance of the device with the essential requirements of the EU-directives.



The UKCA mark proves the compliance of the device with the essential requirements of the UK regulations.



Ex devices have been approved acc. to the ATEX directive for use in connection with installations in explosive areas. See installation instructions.

Safety instructions

Receipt and unpacking

Unpack the device without damaging it and check whether the device type corresponds to the one ordered. The packing should always follow the device until this has been permanently mounted.

Environment

Avoid direct sun light, dust, high temperatures, mechanical vibrations and shock, and rain and heavy moisture. If necessary, heating in excess of the stated limits for ambient temperatures should be avoided by way of ventilation.

The device must be installed in pollution degree 2 or better.

The device is designed to be safe at least under an altitude up to 2000 m.

The device is designed for indoor use.

Mounting

Only technicians who are familiar with the technical terms, warnings, and instructions in the manual and who are able to follow these should connect the device. Should there be any doubt as to the correct handling of the device, please contact your local distributor or, alternatively,

PR electronics A/S
www.prelectronics.com

Mounting and connection of the device should comply with national legislation for mounting of electric materials, e.g. wire cross section, protective fuse, and location.

Descriptions of input / output and supply connections are shown in the block diagram and side label.

The device is provided with field wiring terminals and shall be supplied from a Power Supply having double / reinforced insulation. A power switch should be easily accessible and close to the device. The power switch shall be marked as the disconnecting unit for the device.

SYSTEM 3000 must be mounted on a DIN rail according to EN 60715.

Year of manufacture can be taken from the first two digits in the serial number.

Cleaning

When disconnected, the device may be cleaned with a cloth moistened with distilled water.

Liability

To the extent the instructions in this manual are not strictly observed, the customer cannot advance a demand against PR electronics A/S that would otherwise exist according to the concluded sales agreement.

Mounting / demounting of system 3000

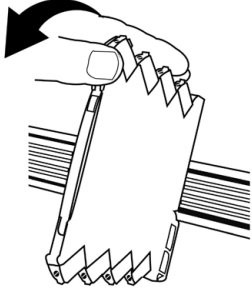
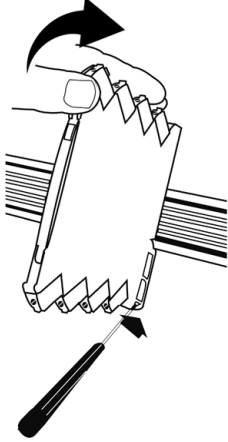
Mounting on DIN rail / power rail (Fig.1)	Demounting from DIN rail / power rail (Fig.2)
<p>Click the device onto the rail</p>	<p>First, remember to demount the connectors with hazardous voltages. Detach the device from the rail by moving the bottom lock down.</p>
	



PR 3114 can be mounted on DIN rail or power rail.

When installing a PR 3114 device with power rail connectors on a standard 7.5 mm DIN rail the head of the screws holding the rail shall be no more than 3.5 mm high to prevent potential short circuit of the power rail connectors.

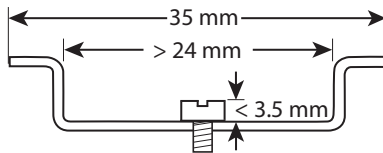

Installation on DIN rail / power rail

PR 3114 can be installed on a DIN rail or on a power rail.

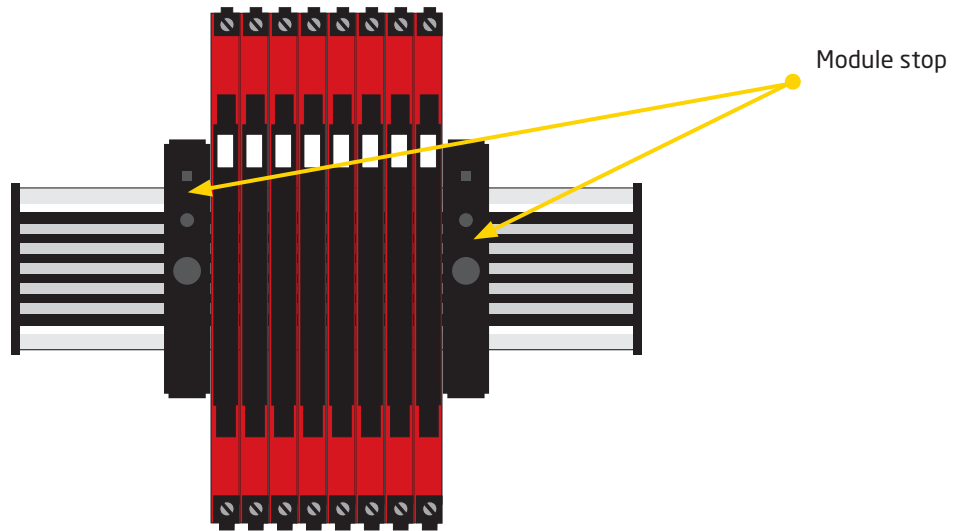

For marine applications, the devices must be supported by a module stop (PR part number 9404).

Power supply units can be mounted on the power rail according to customer requirements.

Marking

The front cover of the PR 3114 has been designed with an area for affixation of a click-on marker. The area assigned to the marker measures 5 x 7.5 mm. Markers from Weidmüller's MultiCard System, type MF 5/7.5, are suitable.

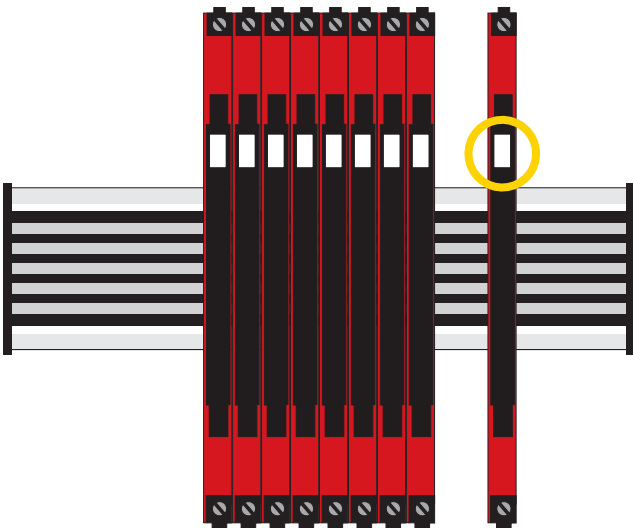

Flexible supply

The technical specifications specify the maximum required power at nominal operating values, e.g. 24 V supply voltage, 60°C ambient temperature, 600 Ω load, and 20 mA output current.

External protective fuses may be required depending on power source selected. Protective fuse ratings are specified below.

DIN rail solution - device daisy chain:

The units can be supplied with 24 VDC \pm 30% via direct wiring and a loop between the devices.

Protective fuse: 2.5 A.

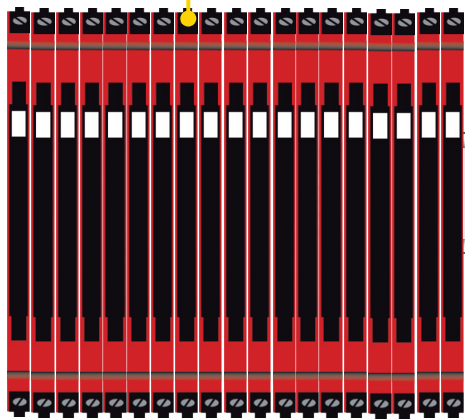

Protective fuse: 0.4 A.

Power rail solution #1:

Alternately, you can connect 24 VDC to any 3000 device with power rail connector which will then energize other units on the rail.

Note:

PR 3114-N can only be supplied via the DIN rail solution with direct wiring on each device.

External fuse characteristics:

The 2.5 A fuse must break after not more than 120 seconds at 6.4 A.

Power rail solution #2:

The PR 3405 power connector unit allows easy connection of a 24 VDC / 2.5 A source to the power rail.

Protective fuse: 2.5 A.

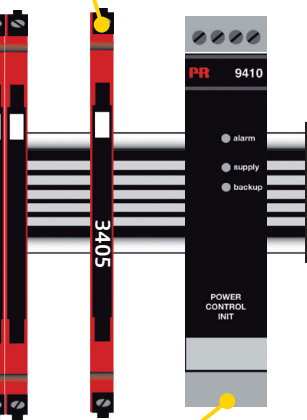

Protective fuse: Located inside the PR 9410.

Power rail solution #3:

The PR 9410 power control unit can energize and power 96 W to the rail. Redundant power supplies are possible.

Isolated universal converter

3114

- Input for RTD, TC, Ohm, potentiometer, mA and V
- 2-wire supply > 15 V
- I.S. approvals: ATEX zone 2, IECEx zone 2, UKEX zone 2 and FM Div. 2
- Output for current and voltage

Applications

- Linearised, electronic temperature measurement with RTD or TC sensor.
- Conversion of linear resistance variation to a standard analog current / voltage signal, i.e. from solenoids and butterfly valves or linear movements with attached potentiometer.
- Power supply and signal isolator for 2-wire transmitters.
- Process control with standard analog output.
- Galvanic separation of analog signals and measurement of floating signals.

Technical characteristics

- A green front LED indicates normal operation and malfunction.
- Continuous check of vital stored data for safety reasons.
- 2.5 kVAC, 3-port galvanic isolation.

Programming

- Configuration, monitoring, and diagnostics using PR 4500 detachable communication interfaces via the PR 4590 ConfigMate. As the 3114 is designed with electronic hardware switches, it is not necessary to open the device for setting of DIP-switches.
- All programming can be password protected.
- Scrolling help text in 7 languages.

Mounting

- Units can be mounted side by side, horizontally and vertically, without air gap on a standard DIN rail, even at 70°C ambient temperature.
- Units can be supplied separately or installed on PR 9400 power rail.
- The narrow 6.1 mm housing allows up to 163 units per meter.

Product overview

PR type no.	3114
PR product name	Isolated universal converter
Description	Universal DC / DC and temperature converter with loop supply output
Parameterisation	PR 4500 communication interfaces / ConfigMate 4590
Input signal	RTD, TC and potentiometer 2-, 3-, and 4-wire 0...10 V 0...20 mA
Sensor type	All standard Pt, Ni, TC
CJC sensor	Internal Pt100
Loop supply output	> 15 V @ 20 mA
Output signal (active)	0...20 mA / 0...10 V
Approvals	UL, safety / FM Div. 2 / ATEX zone 2 / IECEx Zone 2 / UKEX zone 2 / CCC / DNV marine

Connections

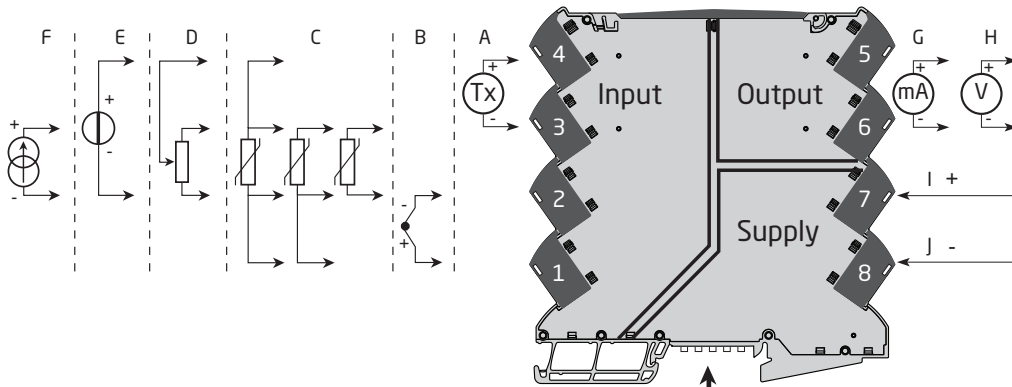

Input signals	
A	Current 1
B	TC
C	RTD
D	Potentiometer
E	Voltage
F	Current 2

Output signals	
G	Current
H	Voltage

Supply	
I	Supply +
J	Supply -
K	Power rail connections (Only type 3114 with power rail option)

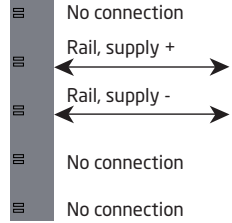

Specifications

Order

Type	Version		
3114	Isolated universal converter	With power rail connector / terminals	: -
		Supplied via terminals	: -N

Example: 3114-N (Isolated universal converter, supplied via terminals)

Accessories

- 4510 = Display / programming front
- 4511 = Modbus communication enabler*
- 4590 = ConfigMate
- 9404 = Module stop for rail

*Note: The PR 4511 communication interface with serial number > 222269001 supports display programming only. Modbus communication is not supported.

Accessories for power rail devices

- 3405 = Power rail connector unit
- 9400 = Power rail - 7.5 or 15 mm high
- 9410 = Power control unit
- 9421 = Power supply

Technical data

Environmental conditions:

- Operating temperature -25°C to +70°C
- Storage temperature -40°C to +85°C
- Calibration temperature. 20...28°C
- Relative humidity < 95% RH (non-cond.)
- Protection degree IP20
- Installation in pollution degree 2 & overvoltage category II.

Mechanical specifications:

- Dimensions (HxWxD) 113 x 6.1 x 115 mm
- Weight approx. 70 g
- DIN rail type. DIN EN 60715 - 35 mm
- Wire size. 0.13...2.5 mm² / AWG 26...12 stranded wire
- Screw terminal torque. 0.5 Nm
- Vibration. IEC 60068-2-6
 - 2...25 Hz. ±1,6 mm
 - 25...100 Hz. ±4 g

Common electrical specifications:

- Supply voltage 16.8...31.2 VDC
- Max. required power. 1.2 W
- Max. power dissipation 0.65 W

Max. required power is the maximum power needed at power supply terminals or rail connector.

Max. power dissipation is the maximum power dissipated at nominal operating values.

Fuse	400 mA SB / 250 VAC
Isolation voltage, test	2.5 kVAC
Isolation voltage working	300 VAC (reinforced) / 250 VAC (Zone 2, Div. 2)
Signal dynamics, input / output	24 bit / 16 bit
Signal / noise ratio	Min. 60 dB (0...100 kHz)
Response time (0...90%, 100...10%):	
Temperature input	1 s
mA / V input	400 ms

Accuracy, the greater of the general and basic values:

General values		
Input type	Absolute accuracy	Temperature coefficient
All	$\leq \pm 0.1\%$ of span	$\leq \pm 0.01\%$ of span / °C

Basic values		
Input type	Basic accuracy	Temperature coefficient
mA	$\leq \pm 16 \mu\text{A}$	$\leq \pm 1.6 \mu\text{A} / ^\circ\text{C}$
0...1 V & 0.2...1 V	$\leq \pm 0.8 \text{ mV}$	$\leq \pm 0.08 \text{ mV} / ^\circ\text{C}$
0...5 V, 1...5 V, 0...10 V & 2...10 V	$\leq \pm 8 \text{ mV}$	$\leq \pm 0.8 \text{ mV} / ^\circ\text{C}$
Pt100, Pt200, Pt 1000	$\leq \pm 0.2^\circ\text{C}$	$\leq \pm 0.02^\circ\text{C} / ^\circ\text{C}$
Pt500, Ni100, Ni120, Ni 1000	$\leq \pm 0.3^\circ\text{C}$	$\leq \pm 0.03^\circ\text{C} / ^\circ\text{C}$
Pt50, Pt400, Ni50	$\leq \pm 0.4^\circ\text{C}$	$\leq \pm 0.04^\circ\text{C} / ^\circ\text{C}$
Pt250, Pt300	$\leq \pm 0.6^\circ\text{C}$	$\leq \pm 0.06^\circ\text{C} / ^\circ\text{C}$
Pt20	$\leq \pm 0.8^\circ\text{C}$	$\leq \pm 0.08^\circ\text{C} / ^\circ\text{C}$
Pt10	$\leq \pm 1.4^\circ\text{C}$	$\leq \pm 0.14^\circ\text{C} / ^\circ\text{C}$
TC type: E, J, K, L, N, T, U	$\leq \pm 1^\circ\text{C}$	$\leq \pm 0.1^\circ\text{C} / ^\circ\text{C}$
TC type: R, S, W3, W5, LR	$\leq \pm 2^\circ\text{C}$	$\leq \pm 0.2^\circ\text{C} / ^\circ\text{C}$
TC type: B 160...400°C	$\leq \pm 4.5^\circ\text{C}$	$\leq \pm 0.45^\circ\text{C} / ^\circ\text{C}$
TC type: B 400...1820°C	$\leq \pm 2^\circ\text{C}$	$\leq \pm 0.2^\circ\text{C} / ^\circ\text{C}$

Conducted RF/LF immunity influence	$< \pm 0.5\%$ of span
Extended EMC immunity: ESD / HF / Burst / Surge immunity influence	$< \pm 1\%$ of span

Auxiliary supplies:

2-wire supply (terminal 3 and 4)	25...15 VDC / 0...20 mA
--	-------------------------

RTD, linear resistance and potentiometer input:

Input type	Min. value	Max. value	Standard
Pt100	-200°C	+850°C	IEC 60751
Ni100	-60°C	+250°C	DIN 43760
Linear resist.	0 Ω	10000 Ω	-
Potentiometer	10 Ω	100 kΩ	-

Input for RTD types:

Pt10, Pt20, Pt50, Pt100, Pt200, Pt250, Pt300, Pt400, Pt500, Pt1000

Ni50, Ni100, Ni120, Ni1000

Cable resistance per wire (max.), RTD 50 Ω

Sensor current; RTD Nom. 0.2 mA

Effect of sensor cable resistance (3- / 4-wire), RTD < 0.002 Ω / Ω

Sensor error detection, RTD Yes

Short circuit detection, RTD < 15 Ω

TC input:

Type	Min. value	Max. value	Standard
B	0°C	+1820°C	IEC 60584-1
E	-100°C	+1000°C	IEC 60584-1
J	-100°C	+1200°C	IEC 60584-1
K	-180°C	+1372°C	IEC 60584-1
L	-200°C	+900°C	DIN 43710
N	-180°C	+1300°C	IEC 60584-1
R	-50°C	+1760°C	IEC 60584-1
S	-50°C	+1760°C	IEC 60584-1
T	-200°C	+400°C	IEC 60584-1
U	-200°C	+600°C	DIN 43710
W3	0°C	+2300°C	ASTM E988-90
W5	0°C	+2300°C	ASTM E988-90
LR	-200°C	+800°C	GOST 3044-84

Cold junction compensation (CJC):

via internal CJC sensor $\pm(2.0^{\circ}\text{C} + 0.4^{\circ}\text{C} * \Delta t)$ Δt = internal temperature - ambient temperature

Sensor error detection, all TC types. Yes

Sensor error current:

when detecting Nom. 2 μA

else. 0 μA

Current input:

Measurement range 0...23 mA

Programmable measurement ranges 0...20 and 4...20 mA

Input resistance Nom. 20 Ω + PTC 50 Ω

Sensor error detection:

Loop break 4...20 mA Yes

Voltage input:

Measurement range 0...12 VDC

Programmable measurement ranges 0...1 / 0.2...1 / 0...5 / 1...5 / 0...10 and 2...10 VDC

Input resistance Nom. 10 MΩ

Current output:

Signal range (span)	0...23 mA
Programmable signal ranges	0...20 / 4...20 / 20...0 and 20...4 mA
Load	≤ 600 Ω
Load stability	≤ 0.01% of span / 100 Ω
Sensor error detection	0 / 3.5 / 23 mA / none
NAMUR NE 43 Upscale/Downscale.	23 mA / 3.5 mA
Output limitation:	
on 4...20 and 20...4 mA signals	3.8...20.5 mA
on 0...20 and 20...0 mA signals	0...20.5 mA
Current limit.	≤ 28 mA

Voltage output:

Signal range.	0...10 VDC
Programmable signal ranges	0...1 / 0.2...1 / 0...10 / 0...5 / 1...5 / 2...10 / 1...0 / 1...0.2 / 5...0 / 5...1 / 10...0 og 10...2 V
Load (min.)	>10 kΩ

of span = of the currently selected measurement range

Observed authority requirements:

EMC.	2014/30/EU & UK SI 2016/1091
LVD	2014/35/EU & UK SI 2016/1101
RoHS	2011/65/EU & UK SI 2012/3032
ATEX	2014/34/EU & UK SI 2016/1107
EAC	TR-CU 020/2011
EAC Ex	TR-CU 012/2011

Approvals:

DNV, Ships & Offshore.	TAA00001RW
c UL us, UL 61010-1.	E314307

I.S. / Ex approvals:

ATEX	KEMA 10ATEX0147 X
IECEX.	KEM 10.0068 X
UKEX.	DEKRA 21UKEX0055X
c FM us.	FM17US0004X / FM17CA0003X
CCC	2020322310003554
EAC Ex	RU C-DK.HA65.B.00355/19

Programming

Default configuration

Input

Input type	Temperature
Voltage input	0...10 V
Current input	4...20 mA
Sensor connection (RTD+resistance)	3 wire
R input range	0...1000
Temperature unit	°C
Temperature type	Pt
Pt type	Pt100
Ni type	Ni100
TC type	K
Display unit	°C
Decimal point	000.0
Display low	0.0
Display high	100.0

Output

Output type	Current
Voltage output	0...10 V
Current output	4...20 mA
Analog out on error	23 mA
Analog out low	0
Analog out high	150
Output limit	No

Advanced

LCD contrast	3
LCD backlight	4
TAG	TAG NO.
Line 3 function	Analog out
Use calibration	No
Enable password protection	No
Calibration range	0.0 / 100.0
Calibration point	0.0 / 100.0
Language	UK

PR 4590 ConfigMate programming

Connect the adapter by opening the front plate on PR 3114 and inserting the jack into the plug.

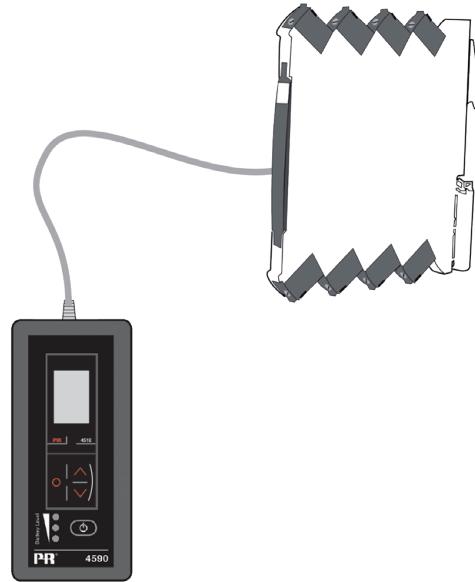

A reference for the complete menu structure and programming options can be found in the section 'Routing diagram' on page 21. For further information on how to navigate and operate the PR 4500 communication interfaces, please refer to www.prelectronics.com/4500/.

Display readout on the PR 4500 of sensor error detection and input signal outside range

Sensor error check:		
Device:	Configuration	Sensor error detection:
3114	OUT.ERR=NONE.	OFF
	Else:	ON

Outside range readout (IN.LO, IN.HI): If the valid range of the A/D converter or the polynomial is exceeded			
Input	Range	Readout	Limit
VOLT	0...1 V / 0.2...1 V	IN.LO	< -25 mV
		IN.HI	> 1.2 V
	0...10 V / 2...10 V	IN.LO	< -25 mV
		IN.HI	> 12 V
CURR	0...20 mA / 4...20 mA	IN.LO	< -1.05 mA
		IN.HI	> 25.05 mA
LIN.R	0...800 Ω	IN.LO	< -10 Ω
		IN.HI	> ca. 1075 Ω
	0...10 kΩ	IN.LO	< -10 Ω
		IN.HI	> 11 kΩ
POTM	0...100%	IN.LO	< -0.5 %
		IN.HI	> 100.5 %
TEMP	TC / Pt100	IN.LO	< temperature range -2°C
		IN.HI	> temperature range +2°C

Display readout below min. / above max. (-1999, 9999):			
Input	Range	Readout	Limit
All	All	-1999	Display readout < -1999
		9999	Display readout > 9999

Sensor error detection limits

Sensor error detection (SE.BR, SE.SH):			
Input	Range	Readout	Condition
CURR	Loop break (4...20 mA)	SE.BR	<= 3.6 mA; > = 21 mA
POTM	All, SE.BR on all 3-wire	SE.BR	> ca. 126 kΩ
LIN.R	0...800 Ω	SE.BR	> ca. 875 Ω
	0...10 kΩ	SE.BR	> ca. 11 kΩ
TEMP	TC	SE.BR	> ca. 750 kΩ / (1.25 V)
	RTD, 2-, 3-, and 4-wire No SE.SH for Pt10, Pt20 and Pt50	SE.BR	> ca. 15 kΩ
		SE.SH	< ca. 15 Ω

Error indications

Readout at hardware error		
Error search	Readout	Cause
CJC sensor error - check device temperature	CJ.ER	Defect internal CJC sensor or CJC temperature out of allowed range**
Flash memory error - default configuration is loaded	FL.ER	Error in FLASH (configuration)*
No communication	NO.CO	No communication
Input error - check input connection and reset power	IN.ER	Error levels on measurement inputs*
Programming mode only - no output signal	PROG.	Offline configuration mode (3114 powered by communications interface)***
Invalid configuration type or version	TY.ER	Configuration read from EEprom has invalid type or rev. no.
Hardware error	RA.ER	RAM memory error*
Hardware error	EE.ER	EEPROM memory error*
Hardware error	NO.CA	Device not factory-calibrated
Hardware error	AD.ER	A/D converter error*
Hardware error	EF.SU	External Flash error*
Hardware error	IF.ER	Internal Flash error*

!	All error indications in the display flash once per second. The help text explains the error. If the error is a sensor error, the display backlight flashes as well - this is acknowledged (stopped) by pushing the  button.
*	Error is acknowledged by entering the menu and saving or by resetting the device power.
**	Error can be disregarded by selecting input type different than TC.
***	Error indication does not flash. Error is acknowledged by connecting device power.

Advanced settings menu

Password protection (PASS): Programming access can be blocked by assigning a password. The password is saved in the device in order to ensure a high degree of protection against unauthorized modifications to the configuration. If the configured password is not known, please contact PR electronics support - www.prelectronics.com/contact.

Memory (MEM): In the memory menu you can save the configuration of the device in the PR 4500 communication interface, and then move the PR 4500 communication interface onto another device of the same type and download the configuration in the new device.

Display setup (DISP): Here you can adjust the brightness contrast and the backlight. Setup of TAG numbers with 6 alphanumeric. Selection of functional readout in line 3 of the display - choose between readout of analog output or tag no.

Two-point process calibration (CAL): The device can be process-calibrated in 2 points to fit a given input signal. A low input signal (not necessarily 0%) is applied and the actual value is entered via the PR 4500 communication interface. Then a high signal (not necessarily 100%) is applied and the actual value is entered via the PR 4500 communication interface. If you accept to use the calibration, the device will work according to this new adjustment. If you later reject this menu point or choose another type of input signal the device will return to factory calibration. Process-calibration is cleared if you edit either of the parameters: input type, input low, input high, display low or display high. Process calibration data are not saved to the configuration repository of the PR 4500 communication interface.

Process simulation function (SIM): Simulation of process value is possible via the up and down arrows, thus controlling the output signal. You must exit the menu by pressing  (no time-out). The simulation function exits automatically if the PR 4500 communication interface is detached.

Power up

Hold \wedge and \vee :
 Toggle Line 3 function between A.Out / TAG.
 (Setting is volatile - use DISP setup menu to change and store Line 3 function.)

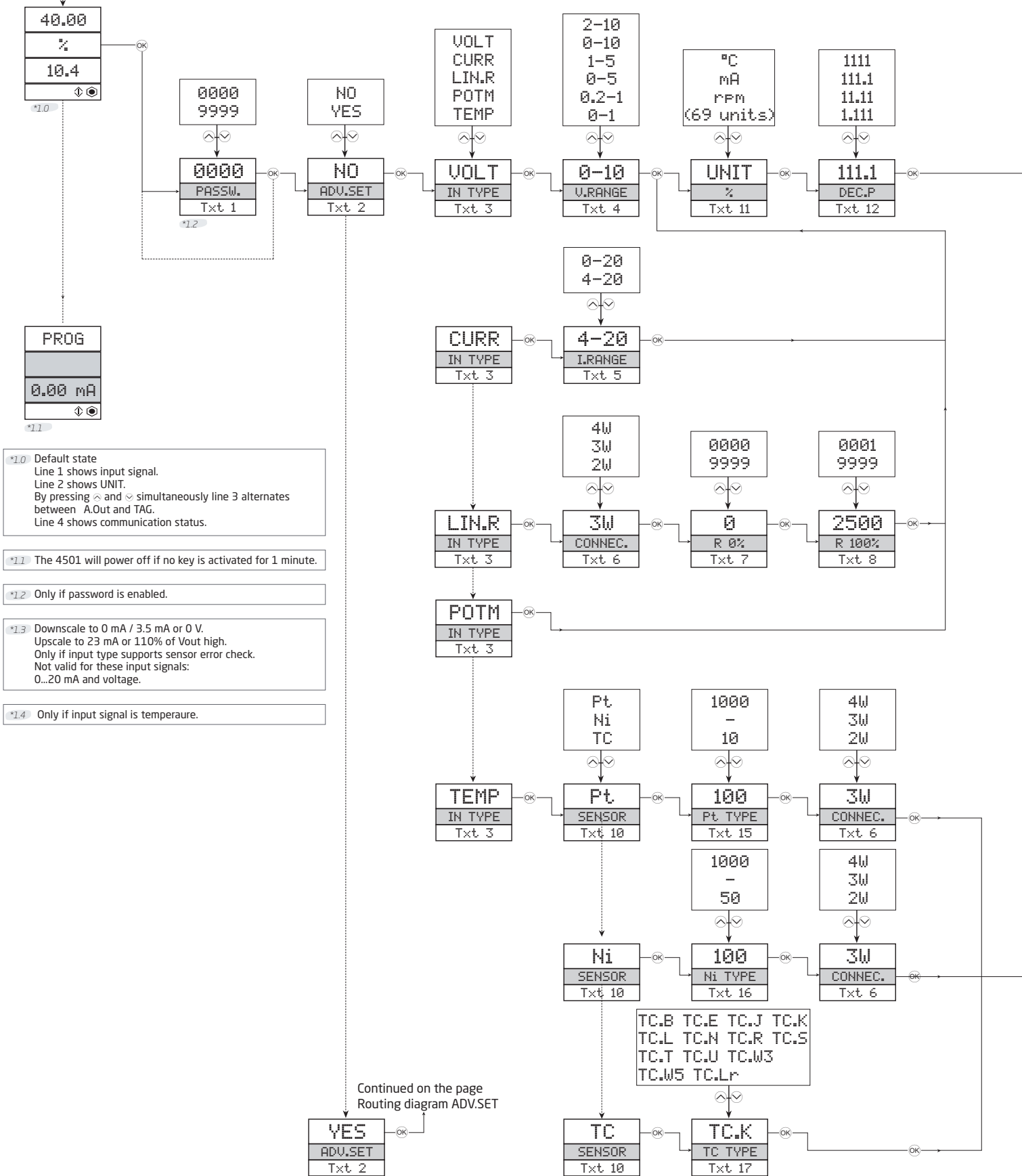

- *1.0 Default state
 Line 1 shows input signal.
 Line 2 shows UNIT.
 By pressing \wedge and \vee simultaneously line 3 alternates between A.Out and TAG.
 Line 4 shows communication status.
- *1.1 The 4501 will power off if no key is activated for 1 minute.
- *1.2 Only if password is enabled.
- *1.3 Downscale to 0 mA / 3.5 mA or 0 V.
 Upscale to 23 mA or 110% of Vout high.
 Only if input type supports sensor error check.
 Not valid for these input signals:
 0...20 mA and voltage.
- *1.4 Only if input signal is temperature.

Continued on the page
 Routing diagram ADV.SET

Routing diagram

If no key is activated for 1 minute, the display will return to the default state 1.0 without saving configuration changes.

- ⬆ Increase value / choose next parameter
- ⬇ Decrease value / choose previous parameter
- ⊗ Save the chosen value and proceed to the next menu
- Hold ⊗ Back to previous menu / return to menu 1.0 without saving.

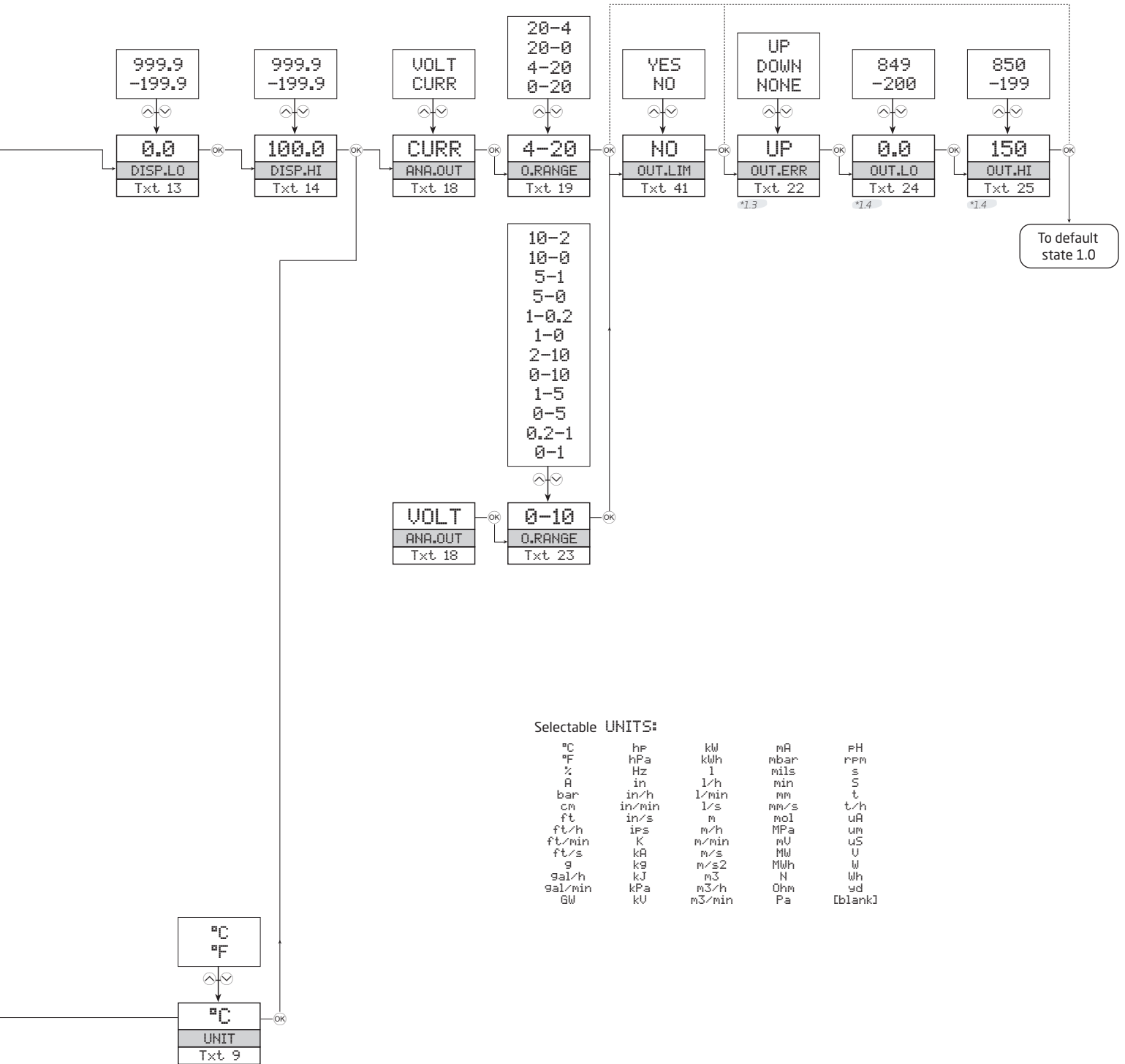

Selectable UNITS:

°C	hPa	kWh	mA	°F
°F	Hz	l	mbar	°C
%	in	1/h	mils	°F
A	in/h	1/min	mm	°C
bar	in/min	1/s	mm/s	°C
cm	in/s	m	mol	°C
ft	ips	m/h	MPa	°C
ft/h	K	m/min	µJ	°C
ft/min	kA	m/s	MJ	°C
ft/s	k9	m/s ²	MWh	°C
g	kJ	m ³	N	°C
gal/h	kPa	m ³ /h	Ohm	°C
gal/min	kV	m ³ /min	Pa	°C
GW				°C

Routing diagram, advanced settings (ADV.SET)

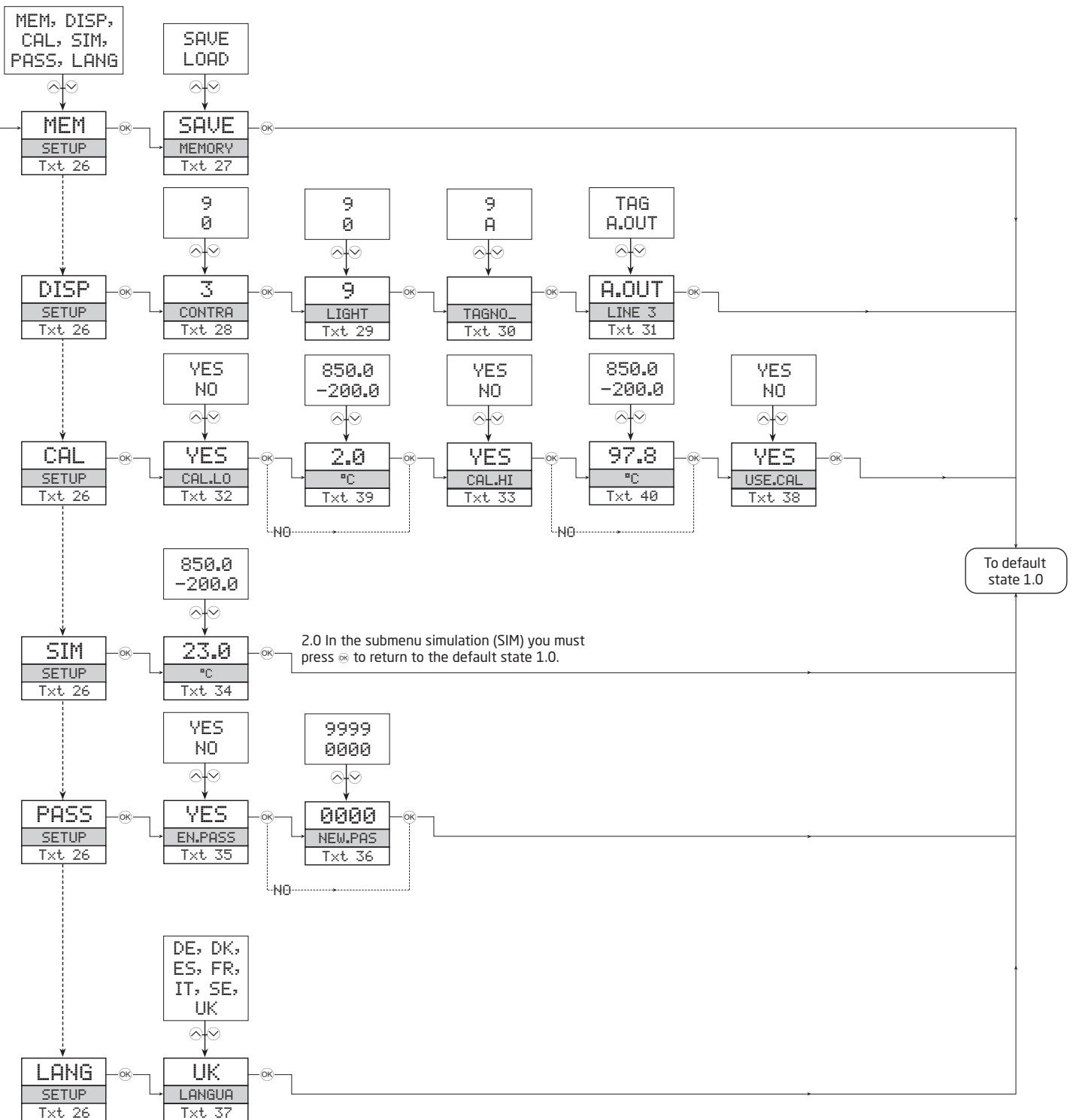

Help text overview

- [01] Set correct password
- [02] Enter advanced setup menu?
- [03] Select temperature input
 - Select potentiometer input
 - Select linear resistance input
 - Select current input
 - Select voltage input
- [04] Select 0.0-1 V input range
 - Select 0.2-1 V input range
 - Select 0-5 V input range
 - Select 1-5 V input range
 - Select 0-10 V input range
 - Select 2-10 V input range
- [05] Select 0-20 mA input range
 - Select 4-20 mA input range
- [06] Select 2-wire sensor connection
 - Select 3-wire sensor connection
 - Select 4-wire sensor connection
- [07] Set resistance value low
- [08] Set resistance value high
- [09] Select Celsius as temperature unit
 - Select Fahrenheit as temperature unit
- [10] Select TC sensor type
 - Select Ni sensor type
 - Select Pt sensor type
- [11] Select display unit
- [12] Select decimal point position
- [13] Set display range low
- [14] Set display range high
- [15] Select Pt10 as sensor type
 - Select Pt20 as sensor type
 - Select Pt50 as sensor type
 - Select Pt100 as sensor type
 - Select Pt200 as sensor type
 - Select Pt250 as sensor type
 - Select Pt300 as sensor type
 - Select Pt400 as sensor type
 - Select Pt500 as sensor type
 - Select Pt1000 as sensor type
- [16] Select Ni50 as sensor type
 - Select Ni100 as sensor type
 - Select Ni120 as sensor type
 - Select Ni1000 as sensor type
- [17] Select TC-B as sensor type
 - Select TC-E as sensor type
 - Select TC-J as sensor type
 - Select TC-K as sensor type
 - Select TC-L as sensor type
 - Select TC-N as sensor type
 - Select TC-R as sensor type
 - Select TC-S as sensor type
 - Select TC-T as sensor type
 - Select TC-U as sensor type
 - Select TC-W3 as sensor type
 - Select TC-W5 as sensor type
 - Select TC-Lr as sensor type
- [18] Select current as analog output type
 - Select voltage as analog output type
- [19] Select 0-20 mA output range
 - Select 4-20 mA output range
 - Select 20-0 mA output range
 - Select 20-4 mA output range
- [22] Select no error action - output undefined at error
 - Select downscale at error
 - Select upscale at error
- [23] Select 0.0-1 V output range
 - Select 0.2-1 V output range
 - Select 0-5 V output range
 - Select 1-5 V output range
 - Select 0-10 V output range
 - Select 2-10 V output range
 - Select 1-0.0 V output range
 - Select 1-0.2 V output range
 - Select 5-0 V output range
 - Select 5-1 V output range
 - Select 10-0 V output range
 - Select 10-2 V output range
- [24] Set temperature for analog output low
- [25] Set temperature for analog output high
- [26] Enter language setup
 - Enter password setup
 - Enter simulation mode
 - Perform process calibration
 - Enter display setup
 - Perform memory operations
- [27] Load saved configuration into device
 - Save configuration in display front
- [28] Adjust LCD contrast
- [29] Adjust LCD backlight
- [30] Write a 6-character device TAG
- [31] Analog output value is shown in display line 3
 - Device TAG is shown in display line 3
- [32] Calibrate input low to process value?
- [33] Calibrate input high to process value?
- [34] Set the input simulation value
- [35] Enable password protection?
- [36] Set new password
- [37] Select language
- [38] Use process calibration values?
- [39] Set value for low calibration point
- [40] Set value for high calibration point
- [41] Limit output values to output range
- [42] Programming mode only - no output signal

Operation & troubleshooting

The 3000 series devices provide multiple features for easy user operation and for performing efficient troubleshooting.

Monitoring the operational status is easy from the front LED.

Status indicator front LED



Condition	LED	Output and loop supply	Action required
No supply / device error or code-flash CRC error	OFF	De-energized	Connect supply / replace device
Power-up or restart	1 Flash (0.5 s OFF + 0.5 s ON)	De-energized	-
Device OK	Flashing 13 Hz (15 ms ON)	Energized	-
Sensor error	Flashing 1 Hz (15 ms ON)	De-energized	Correct setting and re-power device
Restarting due to: Supply error/hardware. RAM or program flow error	Flashing 1 Hz (0.5 s ON)	De-energized	Adjust supply / replace device

Installation instructions

UL installation

Use 60/75°C copper conductors only.

Wire size AWG 26-12

UL file number E314307

The device is an Open Type Listed Process Control Equipment. To prevent injury resulting from accessibility to live parts the equipment must be installed in an enclosure. The power Supply unit must comply with NEC Class 2, as described by the National Electrical Code® (ANSI / NFPA 70).

IECEX, ATEX and UKEX installation in Zone 2

IECEX KEM 10.0068 X Ex ec IIC T4 Gc

KEMA 10ATEX0147 X I 3 G Ex ec IIC T4 Gc

DEKRA 21UKEX0055X II 3 G Ex ec IIC T4 Gc

For safe installation, the following must be observed. The device shall only be installed by qualified personnel who are familiar with the national and international laws, directives and standards that apply to this area.

The devices shall be installed in a suitable enclosure providing a degree of protection of at least IP54 according to EN IEC 60079-0, taking into account the environmental conditions under which the equipment will be used.

When the temperature under rated conditions exceeds 70°C at the cable or conduit entry point, or 80°C at the branching point of the conductors, the temperature specification of the selected cable shall be in compliance with the actual measured temperature.

To prevent ignition of the explosive atmospheres, disconnect power before servicing and do not separate connectors when energized and an explosive gas mixture is present.

For installation on power rail in Zone 2, only Power Rail type 9400 supplied by Power Control Unit type 9410 is allowed.

Do not mount or remove devices from the power rail when an explosive gas mixture is present.

cFMus installation in Division 2 or Zone 2

FM17CA0003X / FM17US0004X Class I, Div. 2, Group A, B, C, D T4 or

Class I, Zone 2, AEx nA IIC T4 or Ex nA IIC T4

In class I, Division 2 or Zone 2 installations, the subject equipment shall be mounted within a tool-secured enclosure which is capable of accepting one or more of Class I, Division 2 wiring methods specified in the National Electrical Code (ANSI/NFPA 70) or in Canada in the Canadian Electrical Code (C22.1).

The 3000 System Isolators and Converters must be connected to limited output NEC Class 2 circuits, as outlined in the National Electrical Code® (ANSI / NFPA 70), only. If the devices are connected to a redundant power supply (two separate power supplies), both must meet this requirement.

Where installed in outdoor or potentially wet locations the enclosure shall at a minimum meet the requirements of IP54.

Warning: Substitution of components may impair suitability for zone 2 / division 2.

Warning: To prevent ignition of the explosive atmospheres, disconnect power before servicing and do not separate connectors when energised and an explosive gas mixture is present.

Warning: Do not mount or remove devices from the power rail when an explosive gas mixture is present.

Document history

The following list provides notes concerning revisions of this document.

Rev. ID	Date	Notes
102	1741	Model 3114-N added. Specifications for max. required power and power dissipation added. PESO/CCOE approval added.
103	2037	PESO/CCOE approval discontinued.
104	2108	CCC approval added. ATEX and IECEx approvals updated - Ex na changed to Ex ec.
105	2217	Side label updated. UKEX approval added.

We are near you, *all over the world*

Our trusted red boxes are supported wherever you are

All our devices are backed by expert service and a 5-year warranty. With each product you purchase, you receive personal technical support and guidance, day-to-day delivery, repair without charge within the warranty period and easily accessible documentation.

We are headquartered in Denmark, and have offices and authorized partners the world over. We are a local

business with a global reach. This means that we are always nearby and know your local markets well. We are committed to your satisfaction and provide **PERFORMANCE MADE SMARTER** all around the world.

For more information on our warranty program, or to meet with a sales representative in your region, visit prelectronics.com.

Benefit today from *PERFORMANCE MADE SMARTER*

PR electronics is the leading technology company specialized in making industrial process control safer, more reliable and more efficient. Since 1974, we have been dedicated to perfecting our core competence of innovating high precision technology with low power consumption. This dedication continues to set new standards for products communicating, monitoring and connecting our customers' process measurement points to their process control systems.

Our innovative, patented technologies are derived from our extensive R&D facilities and from having a great understanding of our customers' needs and processes. We are guided by principles of simplicity, focus, courage and excellence, enabling some of the world's greatest companies to achieve PERFORMANCE MADE SMARTER.